



Rafflesia
INTERNATIONAL & PRIVATE SCHOOLS

Newsletter 2020

SEKOLAH MENENGAH
RAFFLESIA, KAJANG

STAR OF THE WEEK

Tan Kim Guan is very responsible and disciplined. He always completes his homework on time. He participates actively in class discussions and performs excellently in all the class activities. He always tries his level best to attempt a question even though he might be wrong. We are proud to name him the Star of the Week for all the exemplary qualities that he possess. Keep it up!



Tan Kim Guan
Form 5 Respect

Rafflesia Private Schools
Semester 1/21 Week 3 and 4



**Dear Parents and Guardians,
Greetings, from Rafflesia.**

I hope everybody is staying safe at home or at work.

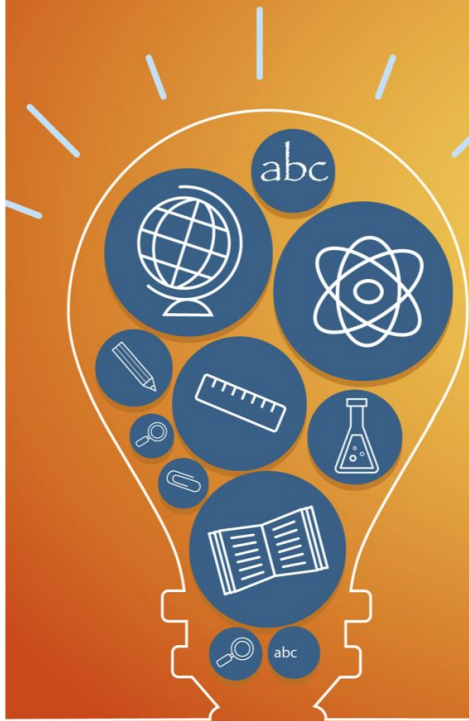

This is the last week of January and we are moving forward very quickly. The weeks in January are filled with interesting activities due to the diverse methods of online teaching by our teachers. Clearly, an excellent achievement to both our students and teachers. We will continue to provide the best solution to support our students' online learning.

As we all know, the MCO 2 is extended and should end by 4th February. The school will continue to update parents with the latest news on related matters. In the meantime, we look forward to planning a Virtual Chinese New Year Celebration amidst the lockdown; a celebration that has been a tradition at Rafflesia. This is the year of the Metal Ox. Let us all pray the Metal Ox year will bring us peace, health and wealth.

On behalf of Rafflesia, we wish you a Happy Chinese New Year. Do take care, stay healthy and enjoy some quality time with your family.

**Madam Zainab Batin
Principal
Rafflesia Private Schools
Kajang**



Learning Science : Virtual Experiments !

Science is a subject related to laboratory activities. It is a knowledge of natural phenomena involving inquiry and discovery through hands-on activities and experiments under the guidance of the teachers (Copriady, 2014).

Studies show that Virtual Laboratories or virtual experiments are able to enhance students' problem solving, critical thinking, creativity, conceptual understanding, science process skills, lab skills, motivation, interest, perception and learning outcomes (Ramadhan & Irwanto, 2017).

Conducting virtual experiments during online lessons can support learning if it is conducted in a proper manner. At Rafflesia, teachers are taking a bold step to teach their students scientific concepts using virtual experiment applications.



Learning Science Form 1 : Virtual Experiments !

Form 1 Science Virtual Experiment: Pendulum

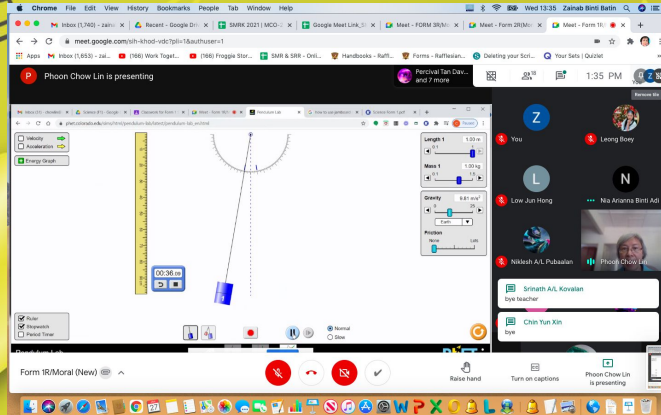

Students investigate how the length of a pendulum influences the time taken for 10 complete oscillations.

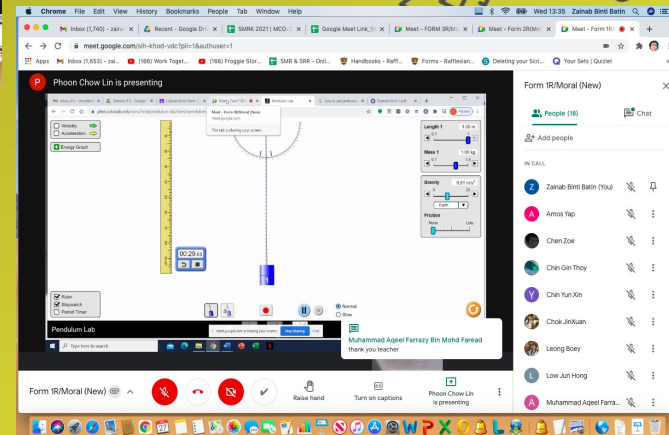



Learning Science Form 1 : Virtual Experiments !

Form 1 Science : Density
of Matter

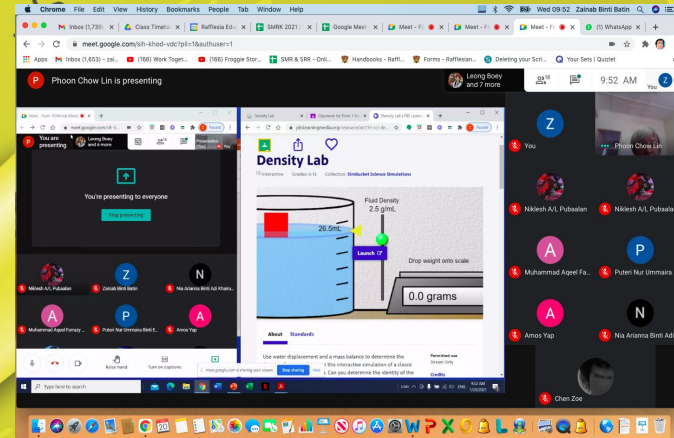

Density measurements use water displacement and a mass balance to determine the density of various objects in the interactive simulation of a classic science laboratory.

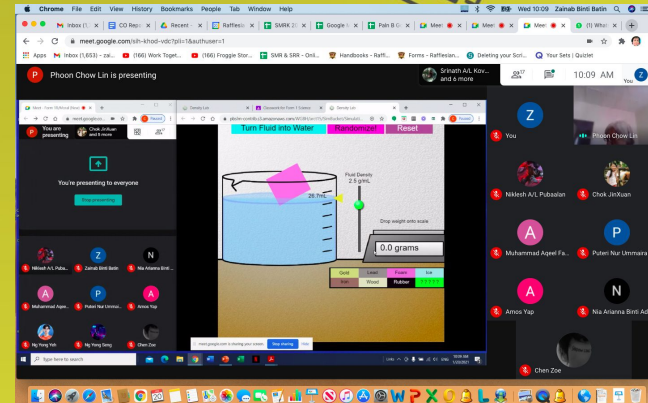



Exciting Learning Tools : Mathematics

Research shows that teachers can integrate technology to help students grasp mathematical procedures and develop advanced mathematical proficiencies.

The National Council of Teachers of Mathematics (NCTM) added that technological tools are necessary for engaging students.

(<https://www.educationworld.com/node/45806>)

At Rafflesia, teachers are very resourceful in providing tools for deeper understanding, especially for online learning.



Exciting Learning Tools : Geogebra

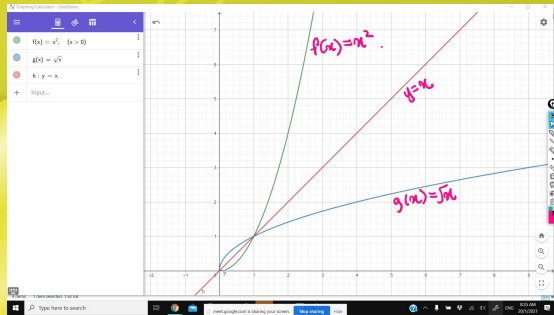

Form 4 STEM
learning
Inverse
Function

What is GeoGebra?

It is a dynamic mathematics software that brings together geometry, algebra, spreadsheets, graphing, statistics and calculus in one easy-to-use package.

Students can have a better illustration to further understand Maths, especially for graphs by using Geogebra software.

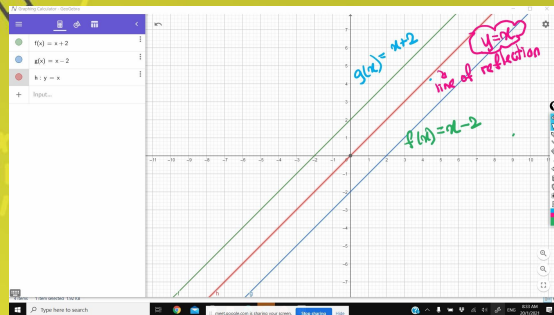



Exciting Learning Tools : Google Jamboard

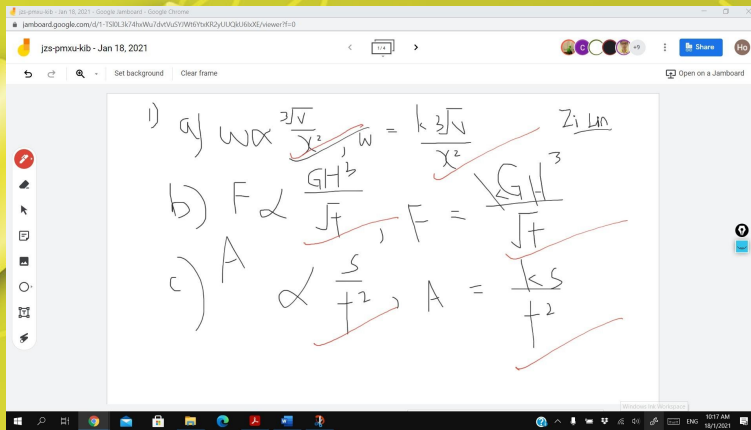

Form 5 Maths students are required to show their answers on Google Jamboard.

Jamboard is an interactive whiteboard system developed by Google as part of Google Workspace.

Students and teachers can interact through Google Jamboard real-time.

The teacher will correct students in real-time if there are any mistakes.

Teachers monitor students' progress and assist instantly just like in traditional physical lessons.



Exciting Learning Tools : You Tube Educational Video

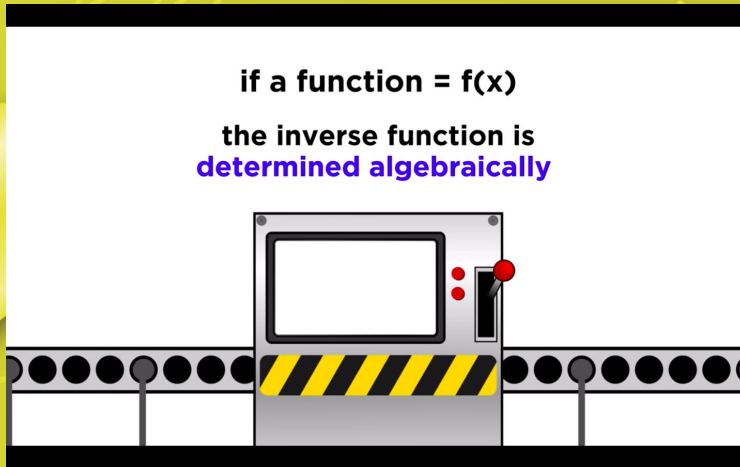

- Form 4 Add Maths students learned the properties of inverse functions by watching a YouTube video shared by the teacher. Students now have a clearer understanding of inverse functions.

An eLearning videos can be a very powerful learning tool, as they add a dynamic element to your eLearning courses, improve knowledge transfer, demonstrate complex procedures, and help explain difficult topics. They can also be particularly entertaining and re-watched as many times as your learners wish.

(<https://elearningindustry.com/8-important-reasons-youtube-part-elearning-course#:~:text=You%20can%20use%20YouTube%20videos,has%20a%20voice%20in%20YouTube.>)



Exciting Learning Tools : Online Quiz using Quizizz

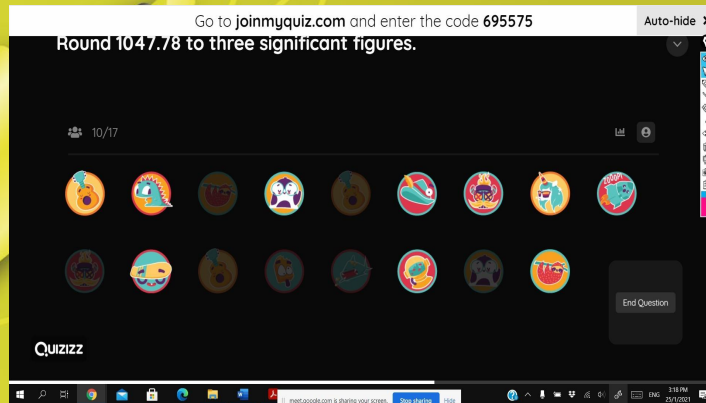

Form 3 Maths students are answering live quiz related to rounding significant figures.

Assessment of learning is a very important component in teaching and learning.

There are many ways of assessing learning. Simple and quick assessments can be used to gauge students' understanding.

Quizizz is one of the best quizzing tools recommended for teachers and students.

(<https://www.common sense.org/education/articles/the-best-quiz-and-game-show-apps-for-classrooms>)



Virtual Formal Assembly : Adapting to the “New Normal”

Adapting to the new normal is not an issue at Rafflesia. Every Monday morning, all students will join a link to attend a Formal Virtual Assembly. Certainly an event not to be missed as everybody must listen to the Principal Address and Important Announcement.

Morning assemblies are important. A school is an institution and like any institution, everyone needs to assemble and meet up regularly to carry out all their duties and be well informed about the school happenings. School is the foundation of a student's life and it helps them to maintain their focus and motivation for learning. The activities carried out during assemblies has the potential to nurture and maintain a positive, healthy school culture which binds everyone together. It is a routine that helps build a good culture of communication.



Virtual Formal Assembly : Adapting to the “New Normal”

The screenshot shows a Zoom meeting in progress. The main display area shows a presentation slide with the following text:

**MADAM ZAINAB
BATIN**
School Principal's speech and
announcement

The slide background features a misty mountain landscape. The Zoom interface includes a top bar with the presenter's name "Maxwell Jared Daniel is presenting", a participant list on the right, and a bottom toolbar with controls like "Raise hand", "Turn on captions", and "Maxwell Jared Daniel is presenting". The system tray at the bottom shows the time as 8:09 AM on 25/1/2021.



Rafflesia
INTERNATIONAL & PRIVATE SCHOOLS

SCHOOL EVENTS AND ACTIVITIES

TRADITIONAL VALUES
GLOBAL VISION

Civics Education : Week 3 Virtual Assembly Love Towards Animal

Maxwell Jared Daniel is presenting

Tan Mei Ying and 45 more

8:20 AM

PENDIDIKAN SIVIK

LOVE

Towards

ANIMALS

CALOE CHEN

Chen Chloe

Rafflesia Private Schools, Kajang Secondary Mo...

Windows Search: Type here to search

Windows Taskbar: 8:20 AM, 18/1/2021



Rafflesia
INTERNATIONAL & PRIVATE SCHOOLS

SCHOOL EVENTS AND ACTIVITIES

TRADITIONAL VALUES
GLOBAL VISION

Civics Education : Week 3 Virtual Assembly Nilai Sivik Kewarganegaraan

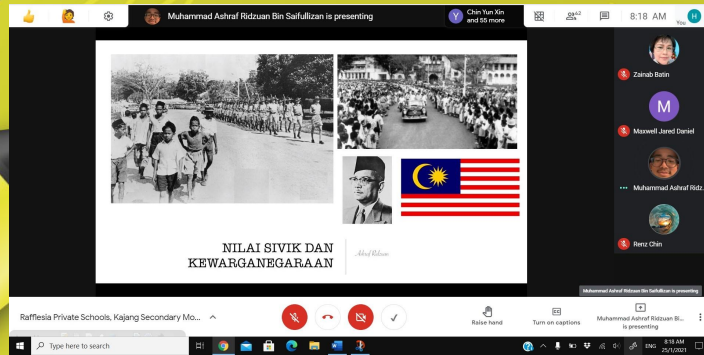



Visual Arts : Chinese New Year e Card Design



Form-3 students applied their skills in digital graphic design by producing Chinese New Year e-Cards,

They practice their proficiency in Canva software by organising and composing the visual elements into one cohesive design.

NURUL ADREANNA ALEESYA



Visual Arts : Chinese New Year e Card Design

NICOLE CHEAH



LEE JIAN TECK



Visual Arts : Chinese New Year e Card Design

TANG HUI JUN



CHLOE CHEN



Visual Arts : Chinese New Year e Card Design

TAN MEI SI



LOKE LI TING



Rafflesia
INTERNATIONAL & PRIVATE SCHOOLS

**SCHOOL EVENTS AND
ACTIVITIES**

**TRADITIONAL VALUES
GLOBAL VISION**

Visual Arts : Chinese New Year e Card Design



LETISHA CHEAH



Important Reminders

- Classroom Based Assessment 1
Classroom Based Assessment 1 will be conducted during Online Class Hours, 1st - 5th March, 2021
- Coffee Morning Session 2
Virtual Coffee Morning will be conducted on Tuesday, February at 8.00 am. Stay tune for the Google Meet Link which will be shared via email.
- Virtual Chinese New Year Celebration is scheduled on Monday, 8th February, 2021 during our Special Assembly. Google Meet Link will be shared via email. All are invited to join and celebrate the new year of the Metal Ox!



Important Reminders

- **Study Skills Camp for Examination Classes (Form 3 and 5) - 23rd - 26th February.**
A special programme to equip exam class students with study and time management skills: this prepares them for their upcoming public examinations in October and November 2021.
- **School Holidays**
School will be taking a short break to celebrate the Chinese New Year.
Virtual School will be closed 11th - 19th February and will reopen on 22nd February.
Happy Holidays!



The Digital Leader Guide to Being Safe Online

S

SAFE: keep your personal information safe

M

MEET: do not agree to meet anyone you only know online

A

ACCEPTING: think carefully before accepting anything online!

R

RELIABLE: you cannot trust everything you see online

T

TELL: tell an adult about anything which makes you unhappy

♥

BE SMART WITH A HEART: treat everyone with respect



Reminder of essential items for students during Online Classes

- Online Class Timetable
- Google Meet Links - Subject/Homeroom Teachers posted on Quickschools.
- Google Classroom (Subjects) Online Resources @ Digital textbooks and other materials.
- Laptop and a good internet connection.
- Conducive Room/Area for Online Class (Good lighting with less disturbance and noise), a chair and a study table.



MATHS BRAIN TEASERS



IF

$$A + C = 4$$
$$D + E = 9$$
$$B + F = 8$$
$$Z + C = 29$$

THEN

$$G + A = ???$$



**Challenge your mind ---> Find the
Answer = 8**



**Challenge your
mind --> Find
the Answer !**



Which tank will fill up first?
Only Genius Can Answer.

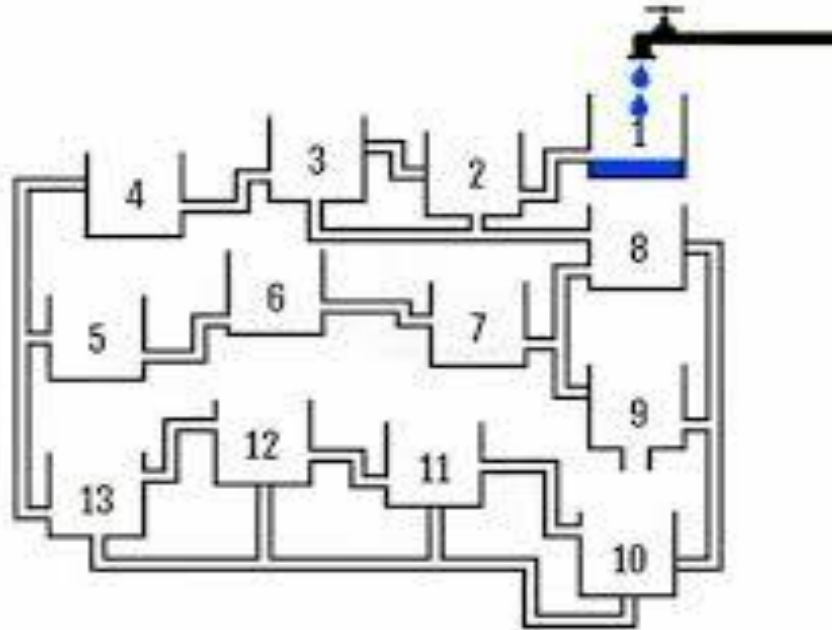



Rafflesia
INTERNATIONAL & PRIVATE SCHOOLS

Newsletter 2020

TRADITIONAL VALUES
GLOBAL VISION

DIFFICULT ROADS
OFTEN LEAD TO
BEAUTIFUL
DESTINATIONS.

WHOWHATWEAR.COM